

4

3

2

1

A

B

C

D

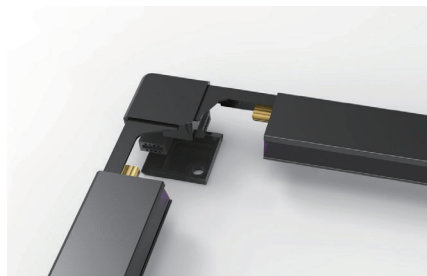

B

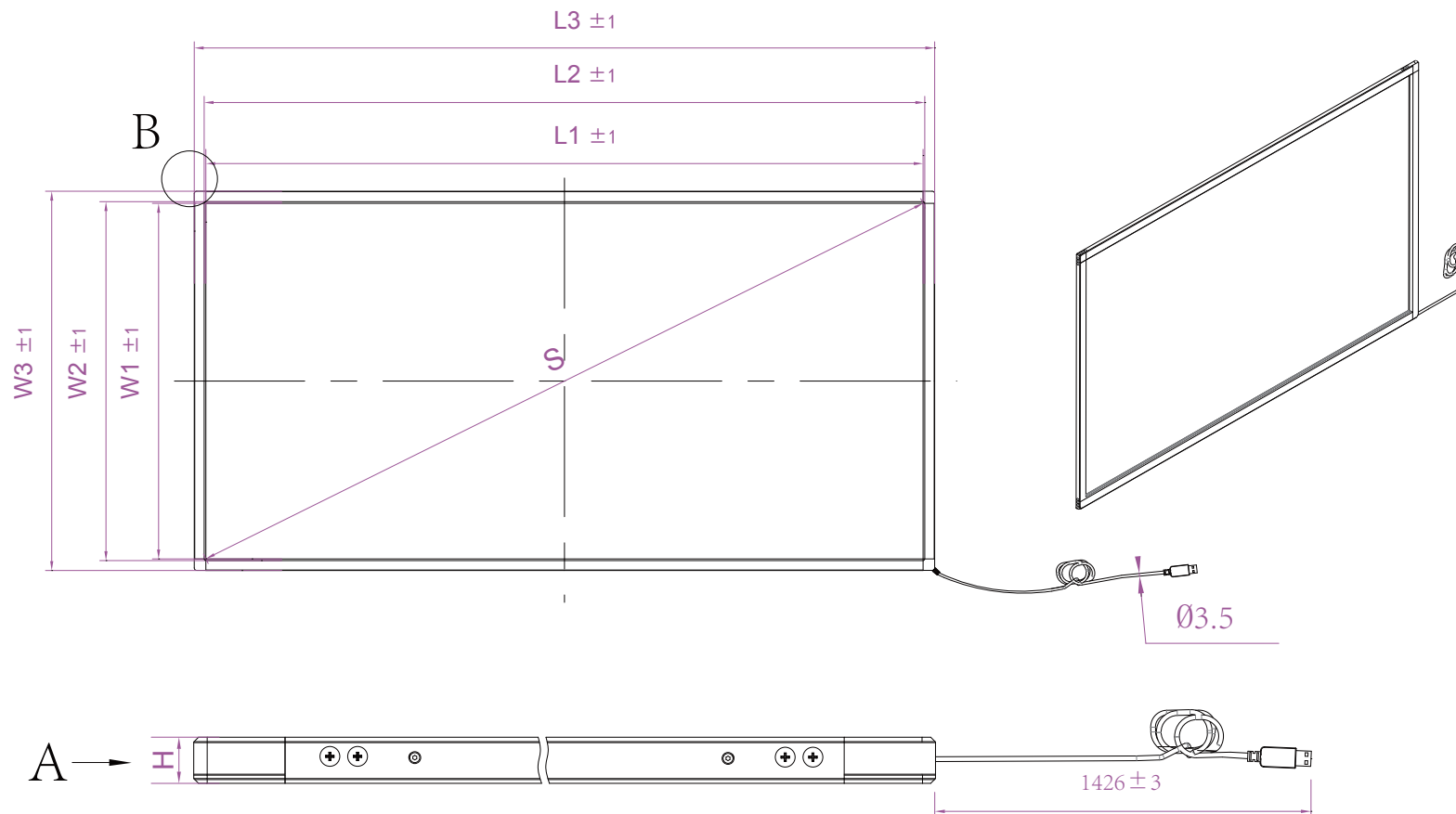

Ø3.5

1426 ± 3

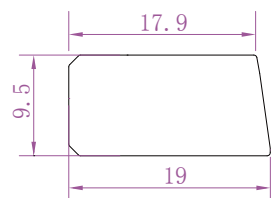

A

S(Inch/mm)	54.75"/1390.82
W1	684.9 ± 1
W2	687.1 ± 1
W3	722.9 ± 1
L1	1210.5 ± 1
L2	1212.7 ± 1
L3	1248.5 ± 1
H	9.5 ± 0.2



Anti-Sunlight, No Blind Zone For Any Size



X Slim Series

Material:	aluminum	Unit:	mm	Date:		Rev:	1.0
Draft by:		Approved by:					

4

3

2

1