

4

3

2

1

A

B

C

D

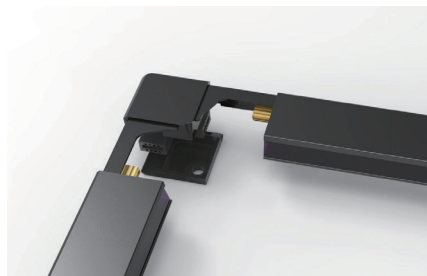

B

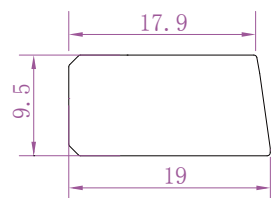
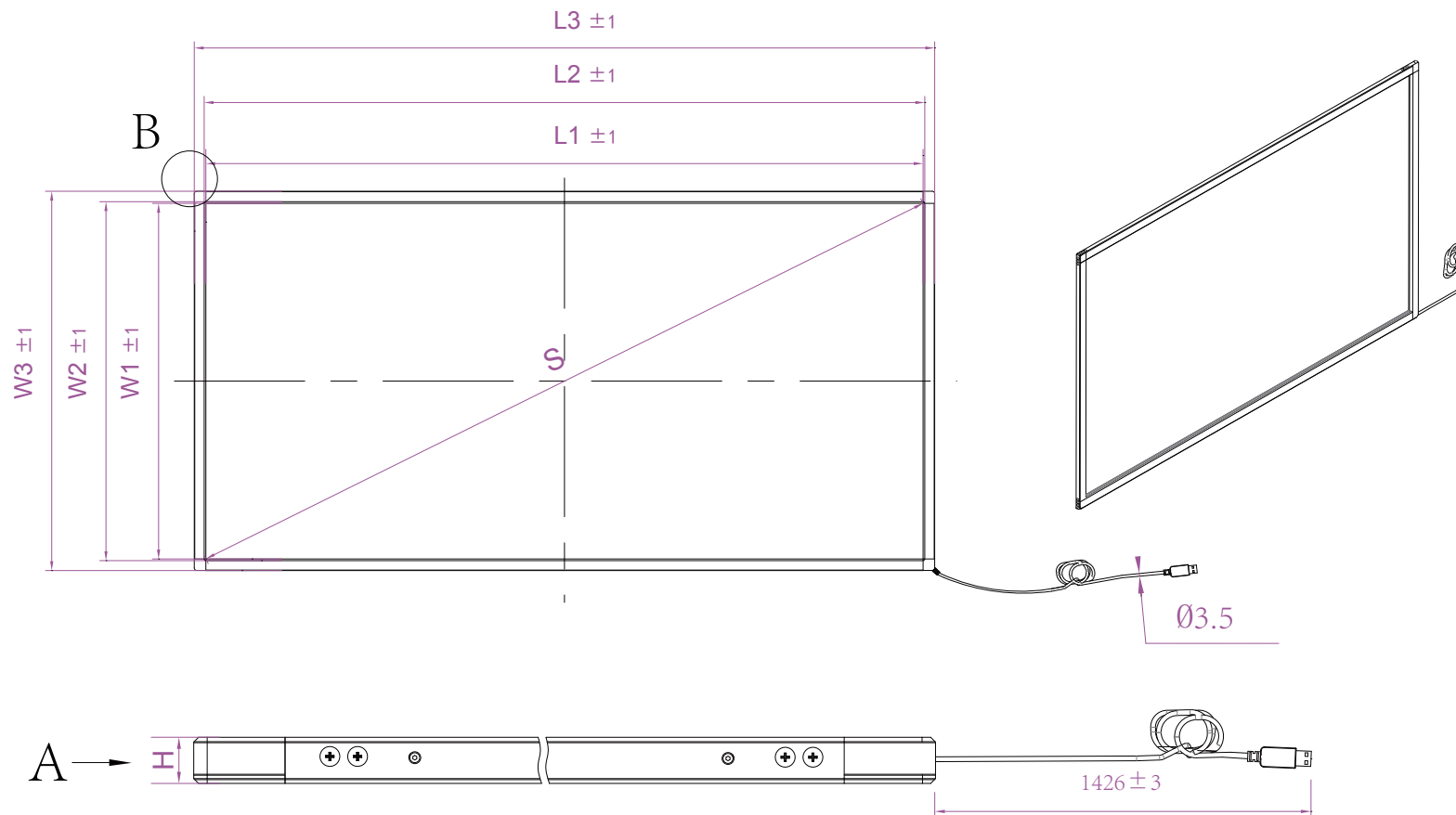

A

A

S(Inch/mm)	57.53"/1461.22
W1	721.8 \pm 1
W2	724.0 \pm 1
W3	759.8 \pm 1
L1	1270.5 \pm 1
L2	1272.7 \pm 1
L3	1308.5 \pm 1
H	9.5 \pm 0.2



Anti-Sunlight, No Blind Zone For Any Size



X Slim Series

Material:	aluminum	Unit:	mm	Date:		Rev:	1.0
Draft by:		Approved by:					

4

3

2

1